

Item No.	Assembly Name
APC-S048	S-4565D Switch 2 (G) 3m/1P+SB

※Attached: S-BOX Support Bracket <D4R-001B>

1	C1S-686G	Pushbutton Switch(Lighted) LB6ML-M1T14G
2	C1S-683R	Emergency Stop Switch(Lighted) XA1E-LV302Q4R

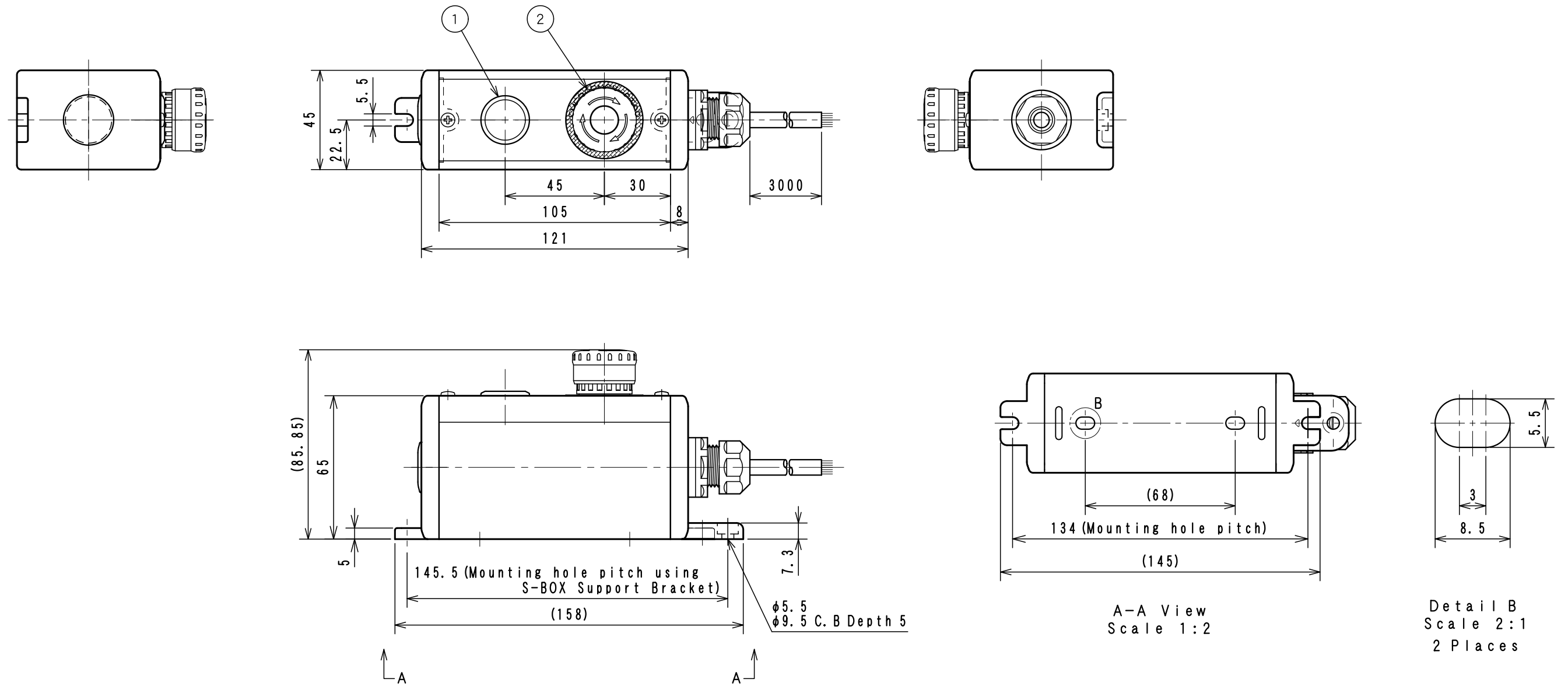

A-A View  
Scale 1:2

Detail B  
Scale 2:1  
2 Places

Applicable Item No.	APC-S046
	APC-S048
	APC-S050

No.	Switch Model No.	Item No.
1	LB6ML-M1T14G	C1S-686G
2	XA1E-LV302Q4R	C1S-683R

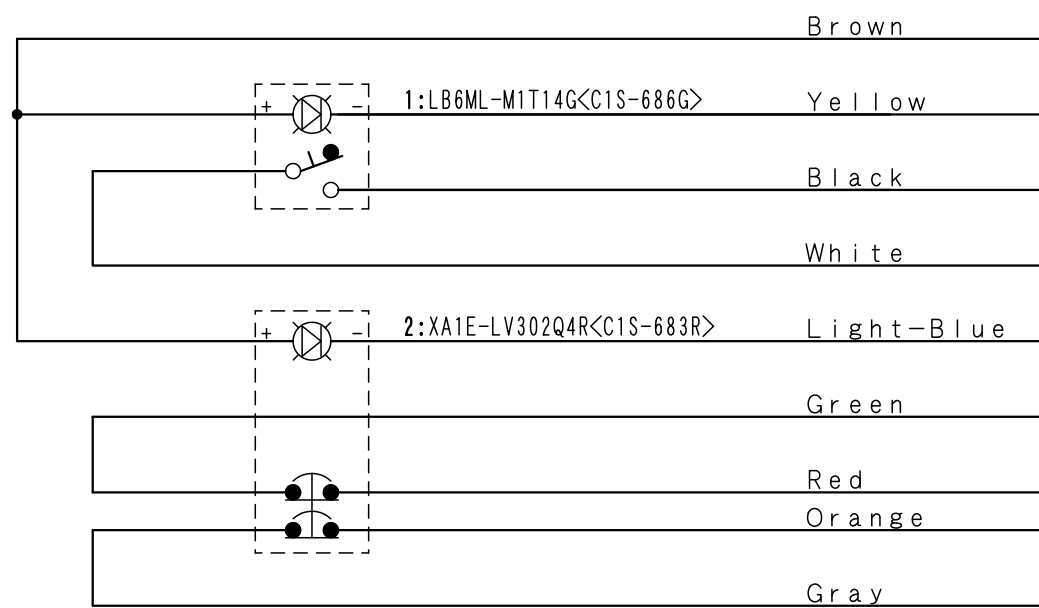

Cable processing detail

