

Item No.	Assembly Name
APC-S059	S-5057D Starting-BOX 40-30E/5m

※Attached:S-BOX Support Bracket <D4R-001B>

<Associated drawings>  
WCW000771-01

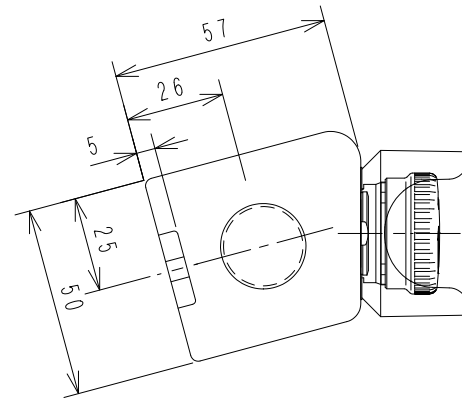

B-B View

1	C1S-248G	Pushbutton Switch(Lighted) Green AF16F0L-C2E3G
2	C1S-757R	Emergency Stop Switch AR16VOL-02E3R
3	C1S-248G	Pushbutton Switch(Lighted) Green AF16F0L-C2E3G

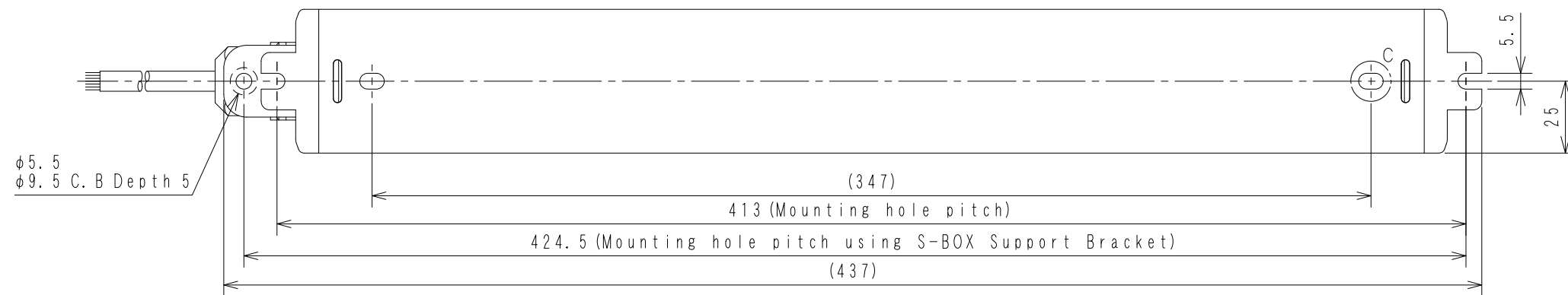
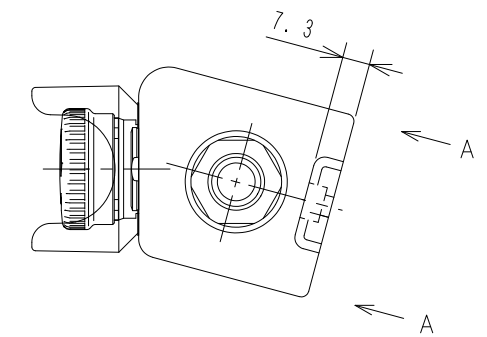
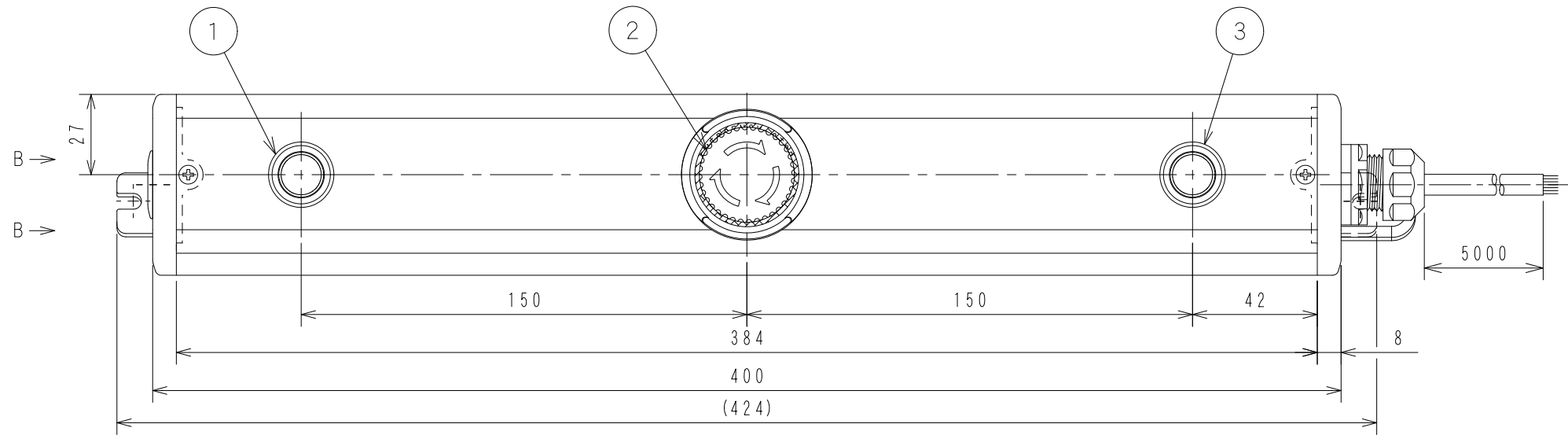

A-A View

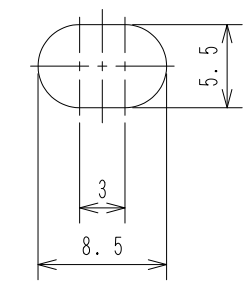

Detail C  
Scale 2:1  
2 Places

Applicable Item No.	APC-S057
	APC-S059

No.	Switch Model No.	Item No.
1	AF16F0L-C2E3G	C1S-248G
2	AR16V0L-02E3R	C1S-757R
3	AF16F0L-C2E3G	C1S-248G

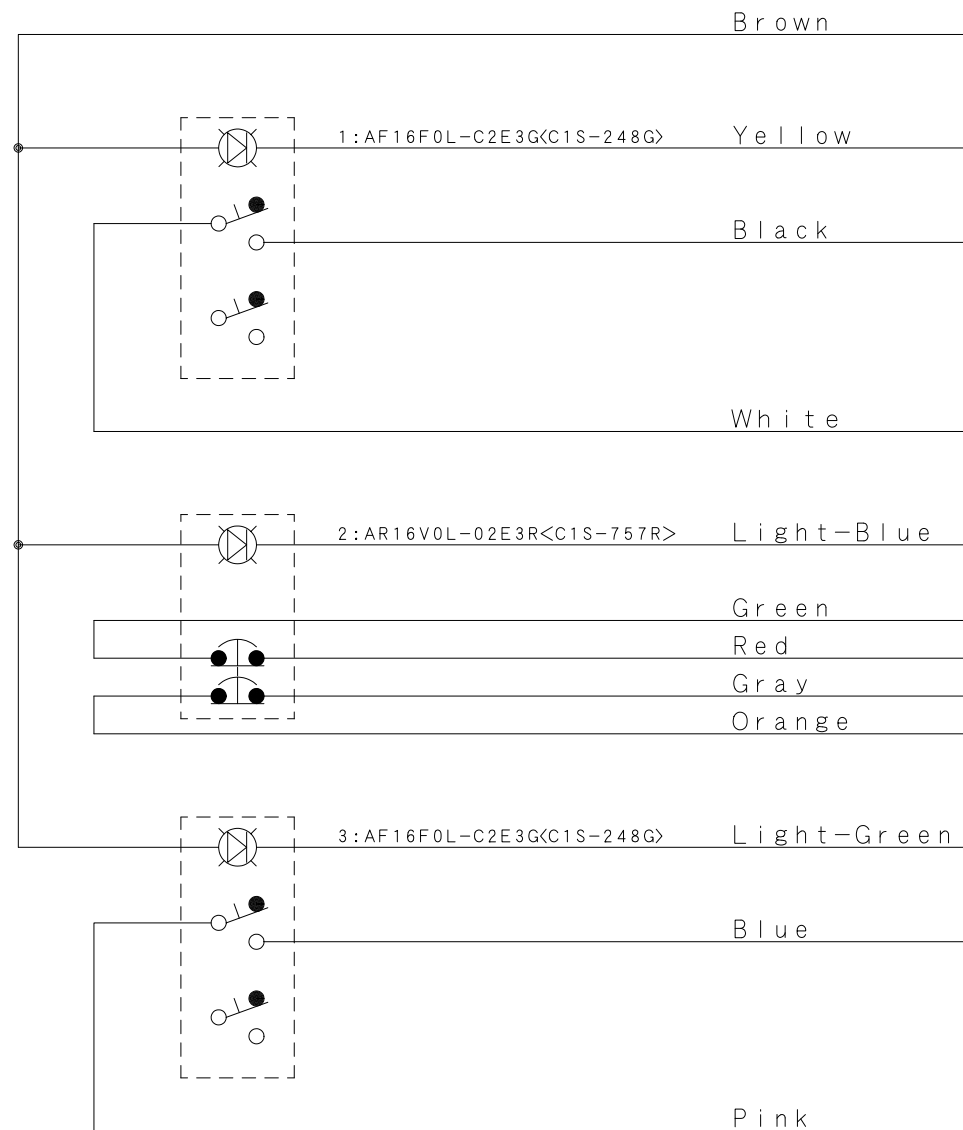

Cable processing detail

