

APC-T022

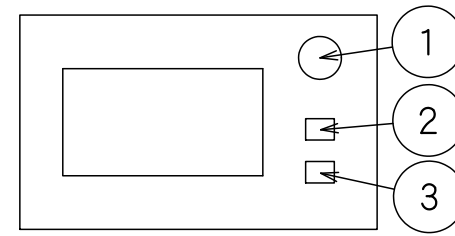

スイッチ配置図

1	C1S-601R	A165E-LS-24D-01
2	C1S-605G	A165L-JGM-24D-1
3	C1S-605R	A165L-JRM-24D-1

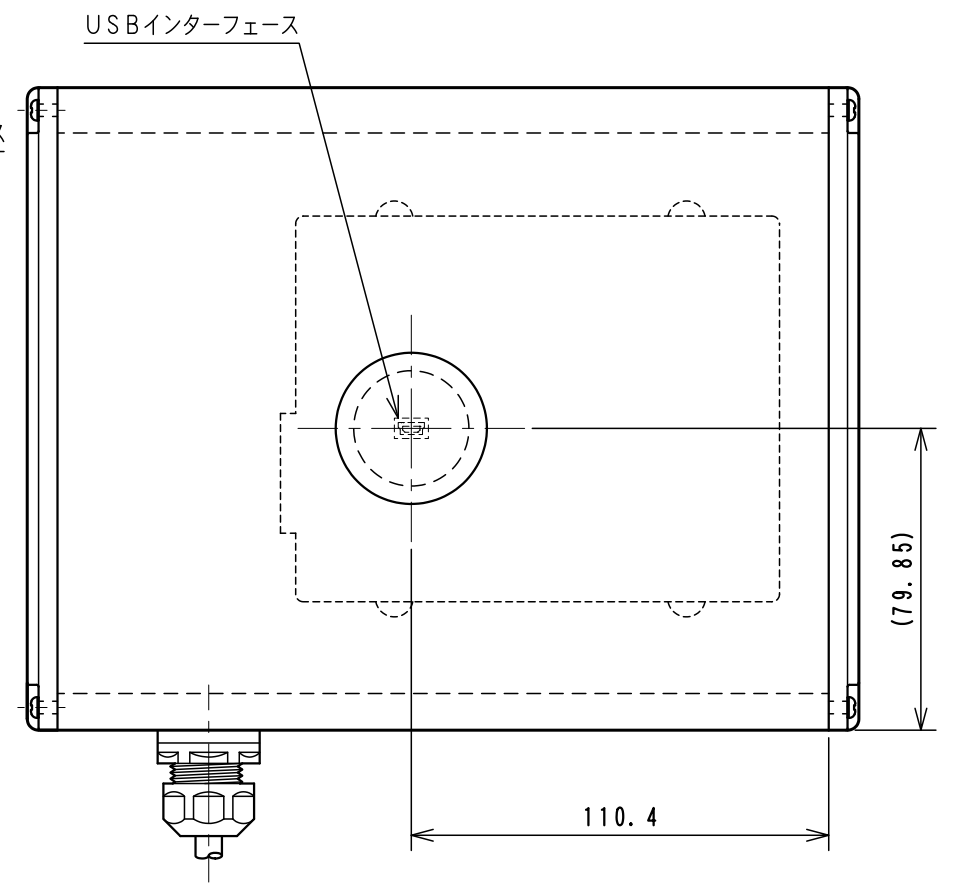
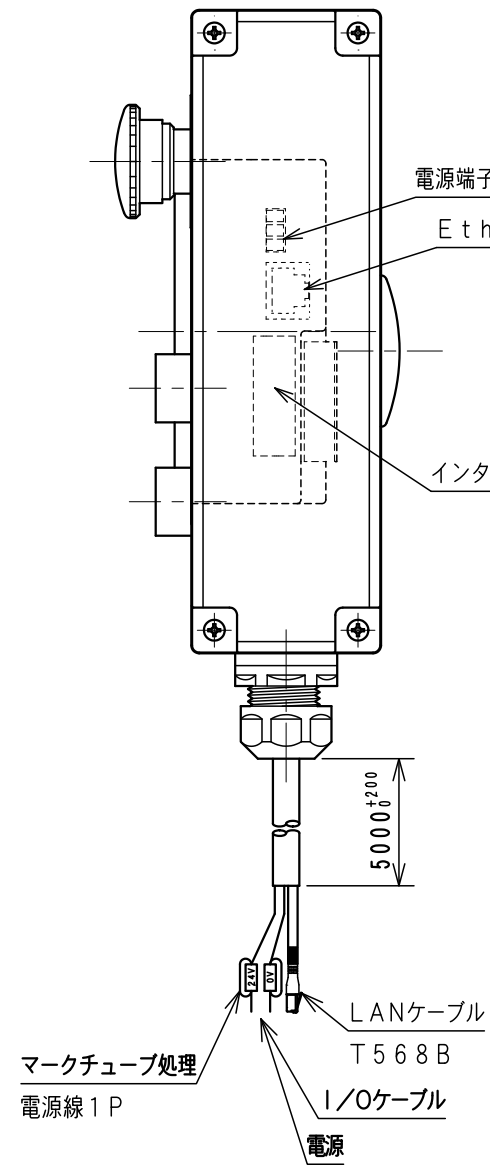
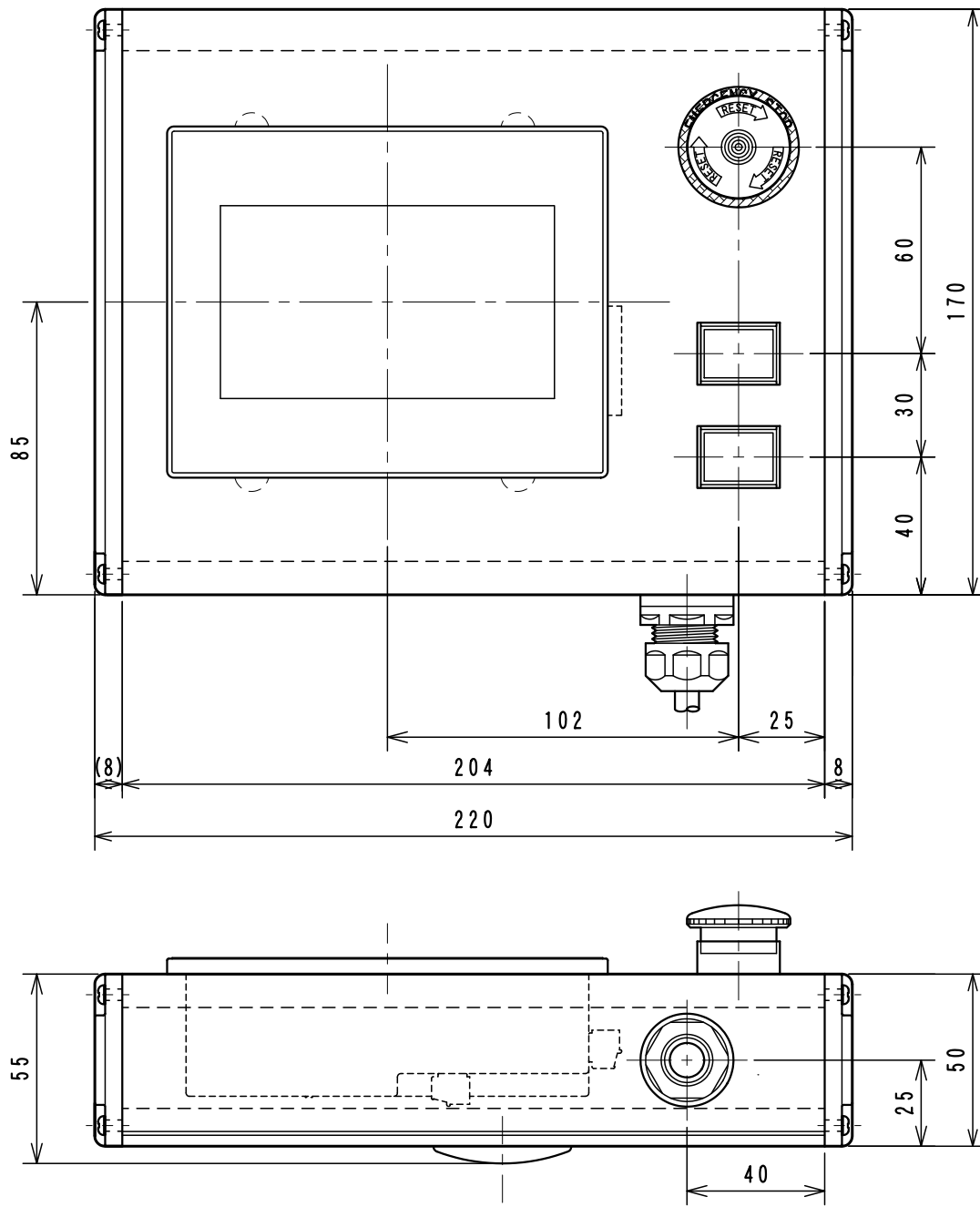

WCW000652-01

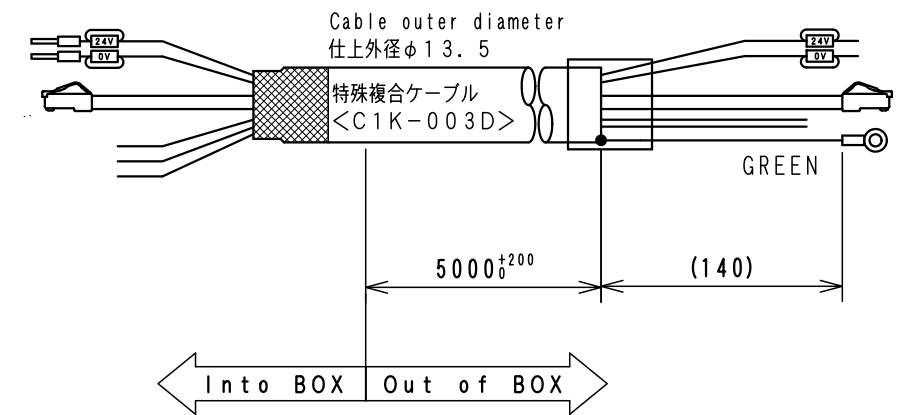
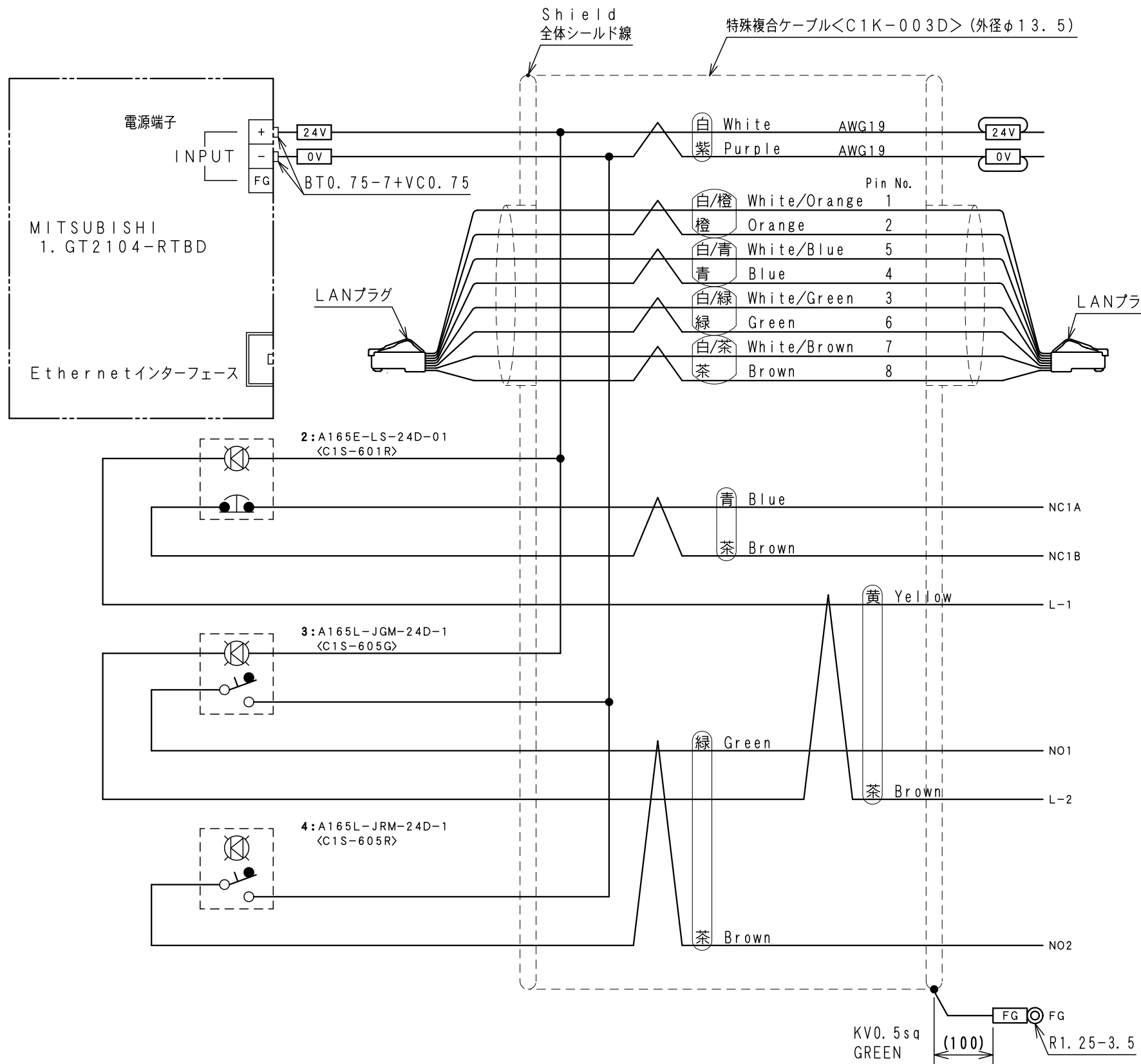

ケーブル処理詳細  
Detail of cable

