

D 6 5
C 3 B - A 6 4 D

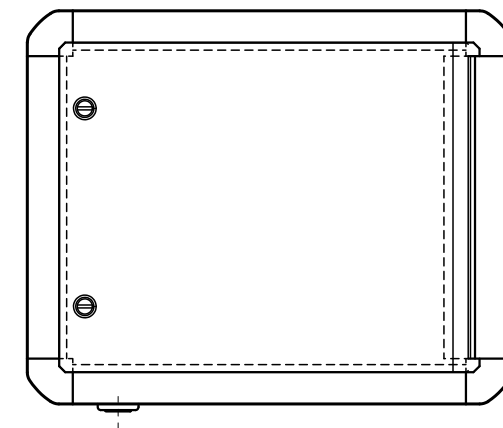
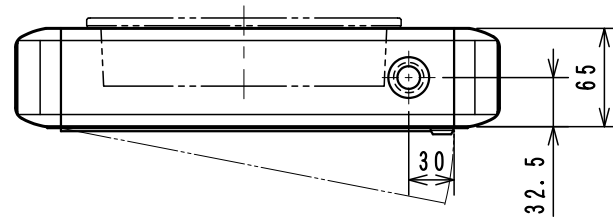
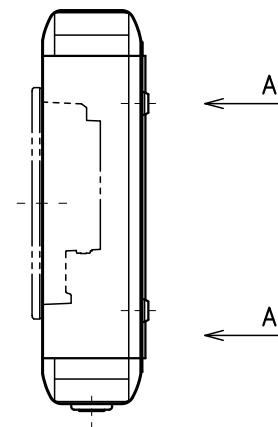
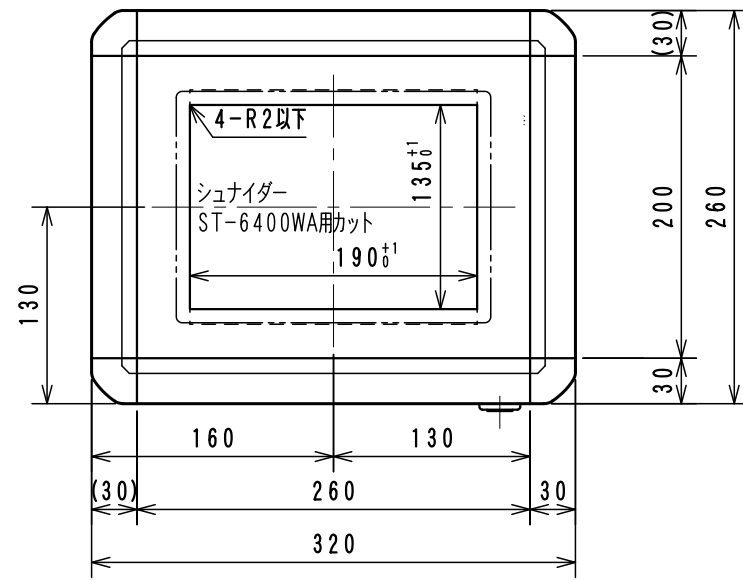

A-A VIEW