

Item No.	Assembly Name
NJC-10A	S-6480D Switch 1/1m 1P+SB

※Attached: S-BOX Support Bracket <D4R-001B>

1	C1S-231R	Emergency Stop Switch (Lighted)	AR22VAL-11E3R
---	----------	---------------------------------	---------------

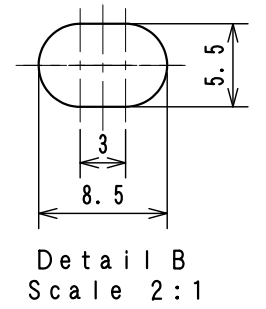
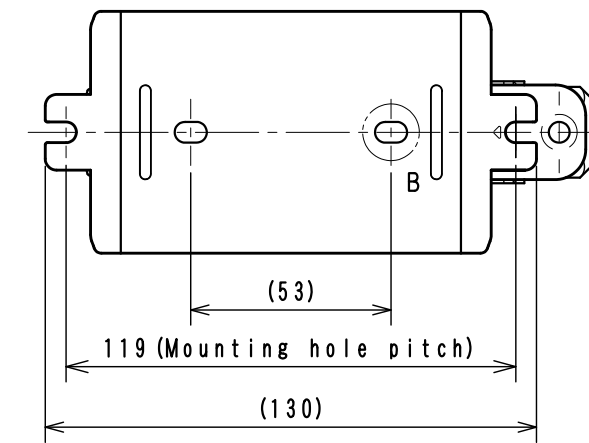
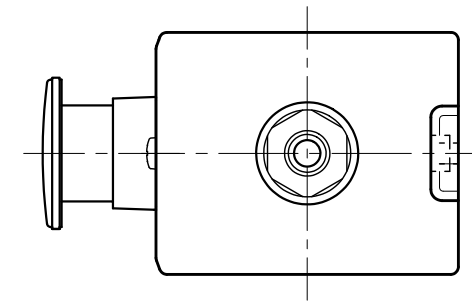
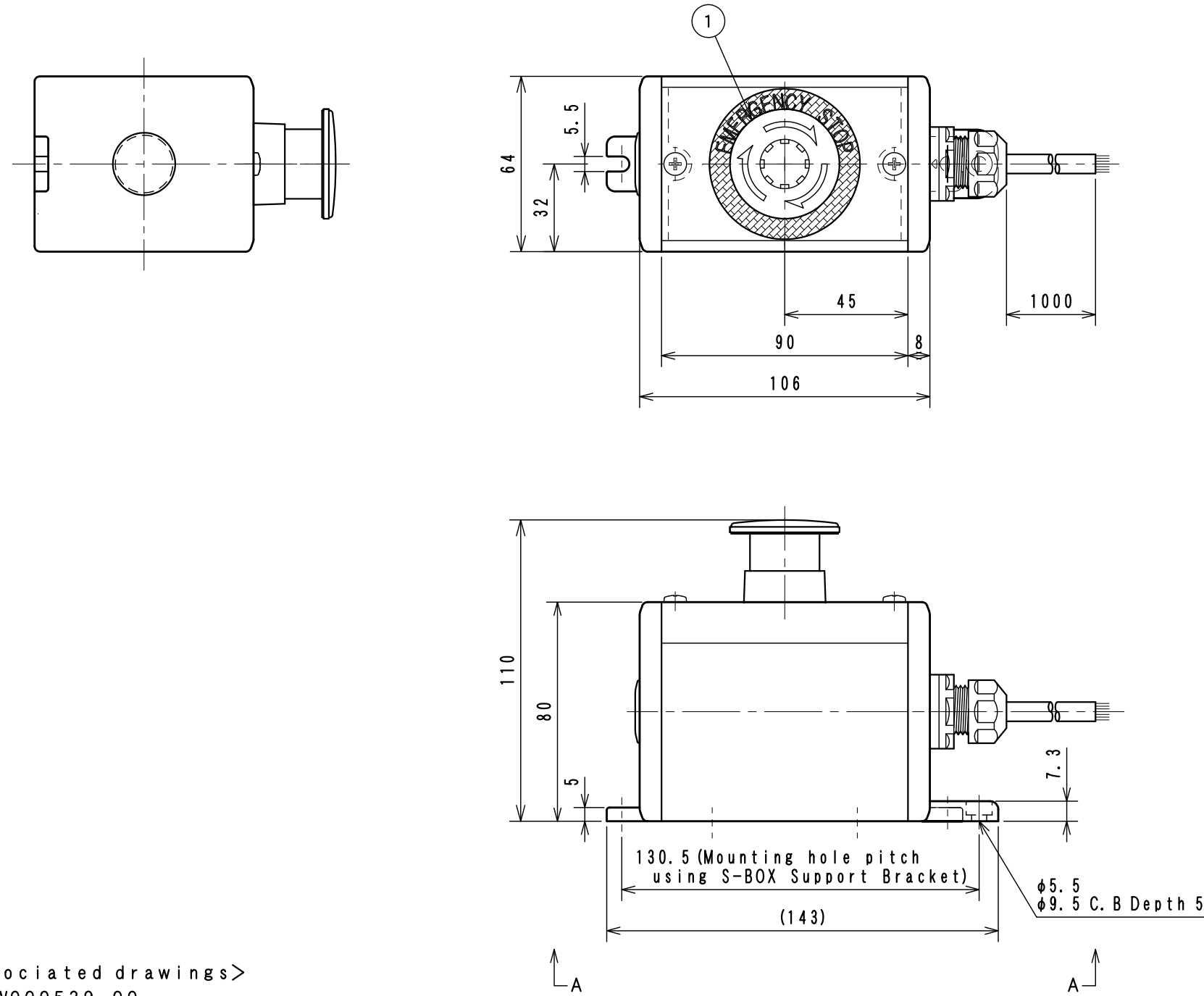

A-A View
Scale 1:2

Detail B
Scale 2:1

<Associated drawings>
WCW000539-00

Applicable Item No.	NJC-10A
	NJC-11A
	NJC-12A

No.	Switch Model No.	Item No.
1	AR22VAL-11E3R	C1S-231R

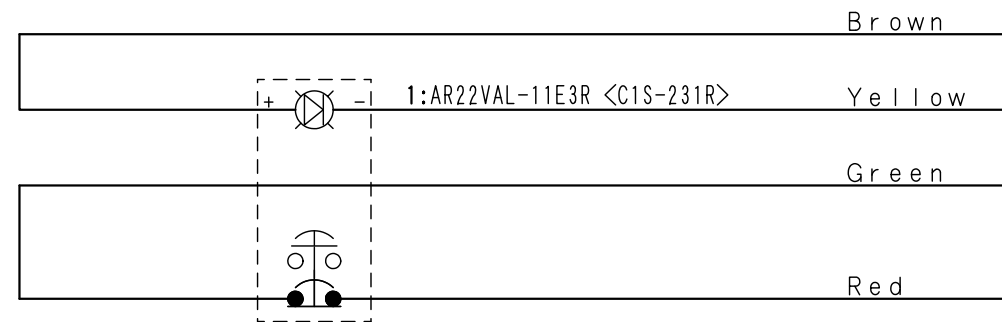

Cable processing detail

