

Item No.	Assembly Name
NJC-123	S-5057D Switch 1/1m 1P+SB

※Attached: S-BOX Support Bracket <D4R-001B>

1	C1S-759R	Emergency Stop Switch (Lighted) AR16V1L-02E3R
---	----------	---

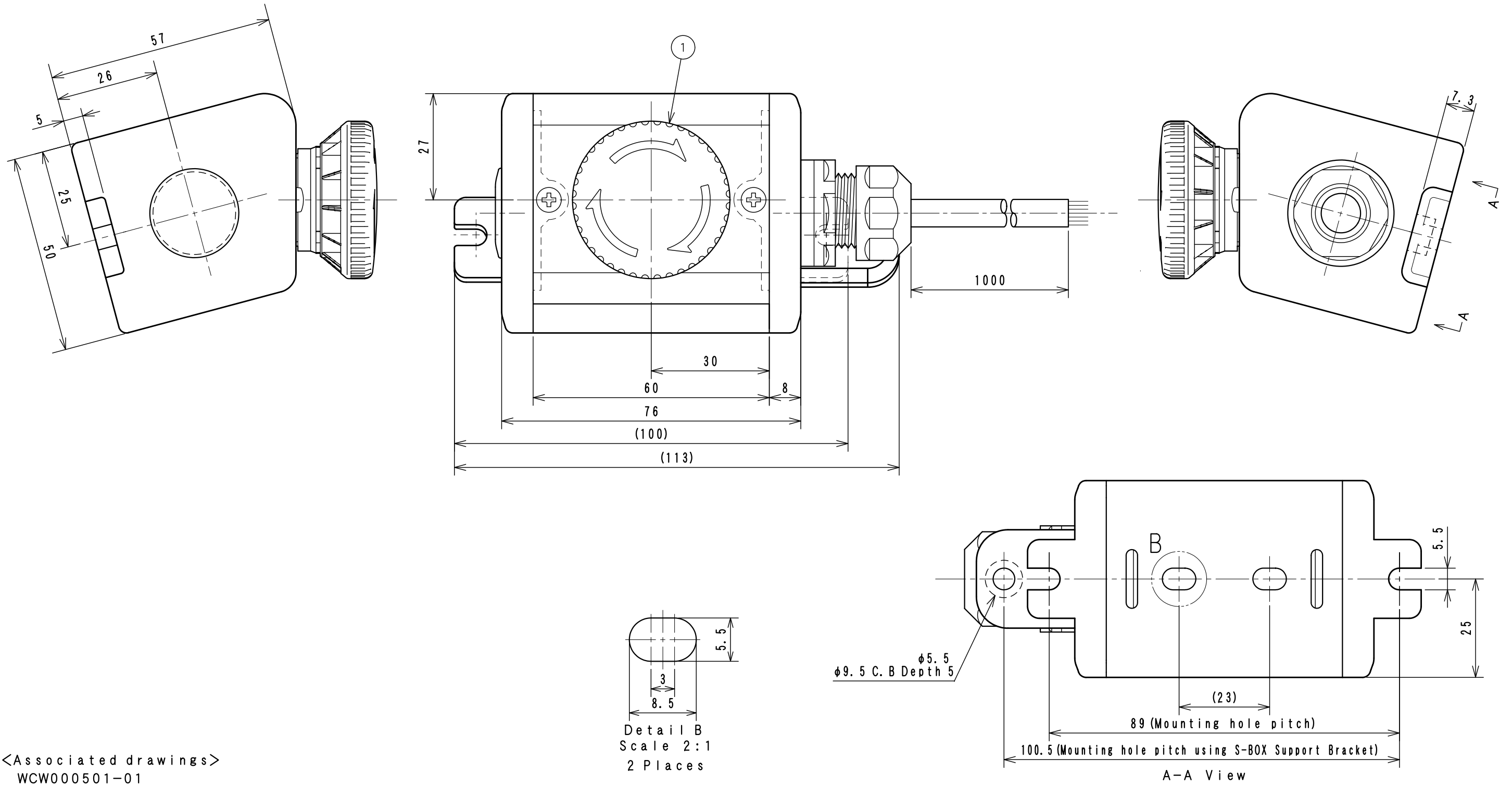

<Associated drawings>
WCW000501-01

Applicable Item No.	NJC-113
	NJC-123

No.	Switch Model No.	Item No.
1	AR16V1L-02E3R	C1S-759R

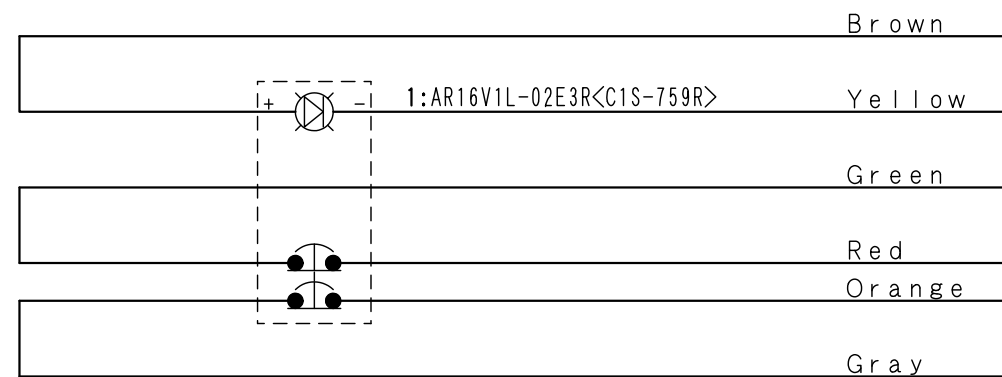

Cable processing detail

